

Model No. A12-L3501-2

2" RANDOM ORBITAL SANDER

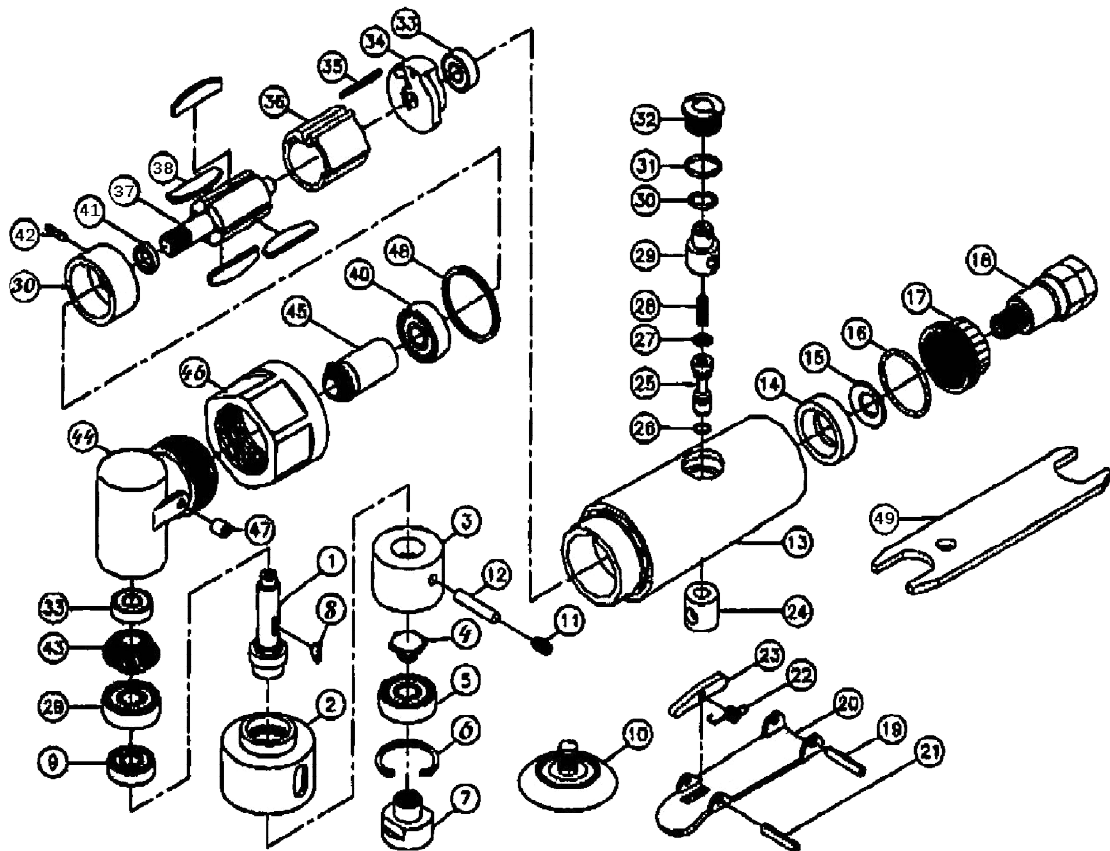

Part No.	Description	Q'ty	Part No.	Description	Q'ty	Part No.	Description	Q'ty
1	Spindle	1	18	Air Inlet	1	35	Cylinder Pin	1
2	Guard Cover	1	19	Lever Pin	1	36	Cylinder	1
3	Balance Weight	1	20	Throttle Lever	1	37	Rotor	1
4	Nut Screw	1	21	Spring Pin	1	38	Rotor Blade	4
5	6001 Bearing	1	22	Spring	1	39	Front End Plate	1
6	Inverted Retaining Ring	1	23	Stop Rod	1	40	608 Ball Bearing	2
7	Pad Screw	1	24	Valve Bushing	1	41	Rotor Spacer	1
8	Key	1	25	Valve Stem	1	42	Pin	1
9	698 Bearing	1	26	O-Ring	1	43	Bevel Gear	1
10	2" Sanding Pad	1	27	O-Ring	1	44	Angle Head Housing	1
11	M6x1P Screw	1	28	Spring	1	45	Pinion	1
12	ø4x18 Pin	1	29	Regulator	1	46	Housing Lock Ring	1
13	Motor Housing	1	30	O-Ring	1	47	Grease Fitting	1
14	Silencer	1	31	O-Ring	1	48	Collar	1
15	Washer	1	32	Valve Screw	1	49	Spanner Wrench 17mm	1
16	O-Ring	1	33	Ball Bearing	2			
17	Deflector	1	34	Rear End Plate	1			